

HarmonicDrive® Ultra-light Weight / Flat* Unit Type CSF-ULW Series

Full lineup

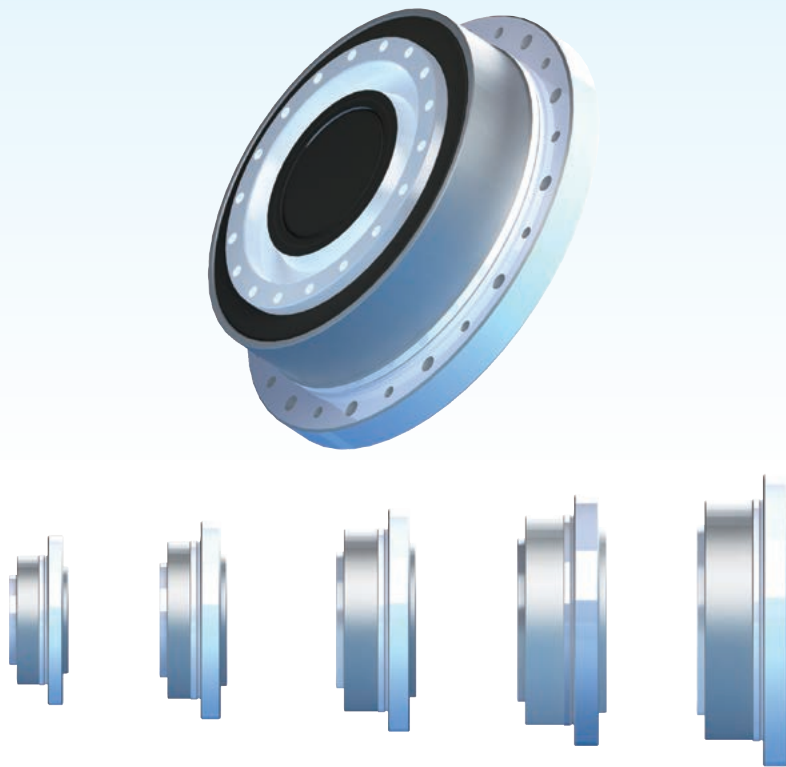

**We have just achieved the weight reduction and flat shape
of our products as never before.**

Our company has added a new series that pursues lightweight and flat shapes in HarmonicDrive® unit products.

We have also redesigned the structure and design of the CSF-2UH type, which is the main product of the unit products, and realized a lighter weight and flatter shape than ever before. By adopting them in the tip axis of robots and various mechanical devices, our new series can be used to reduce the weight and size of robots and equipment as well as to improve specifications. You can choose the optimal specifications from wide variations offered in 5 sizes.

* Ultra-light weight/Flat compared with our conventional products. For more details, please refer to page 2 of this catalog.

Feature

- A full lineup of 5 sizes
- We have also achieved the same performance as the other existing series (main bearing performance is excluded).

Comparison of Mass

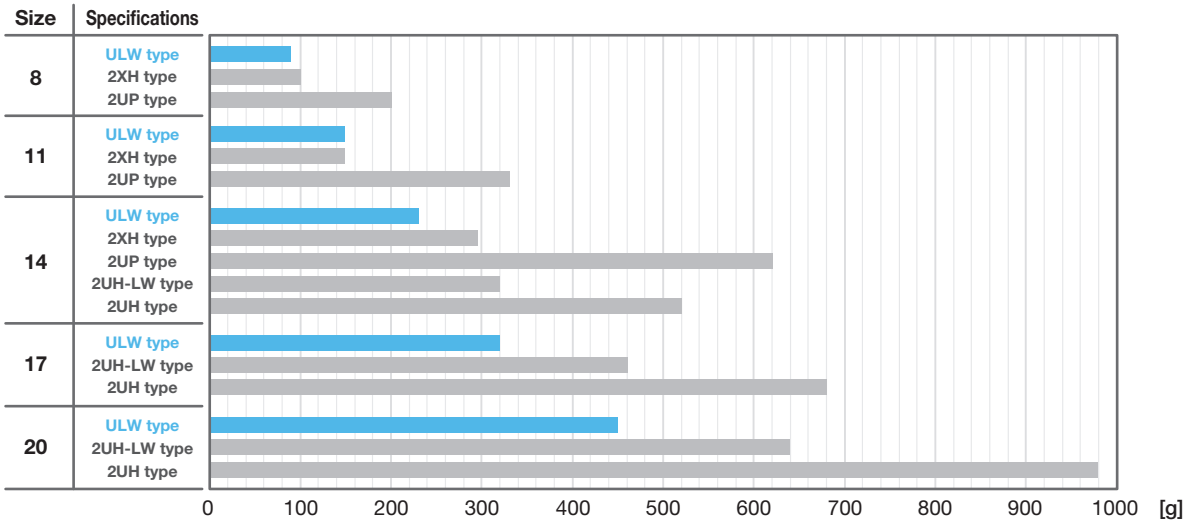

Comparison of full length

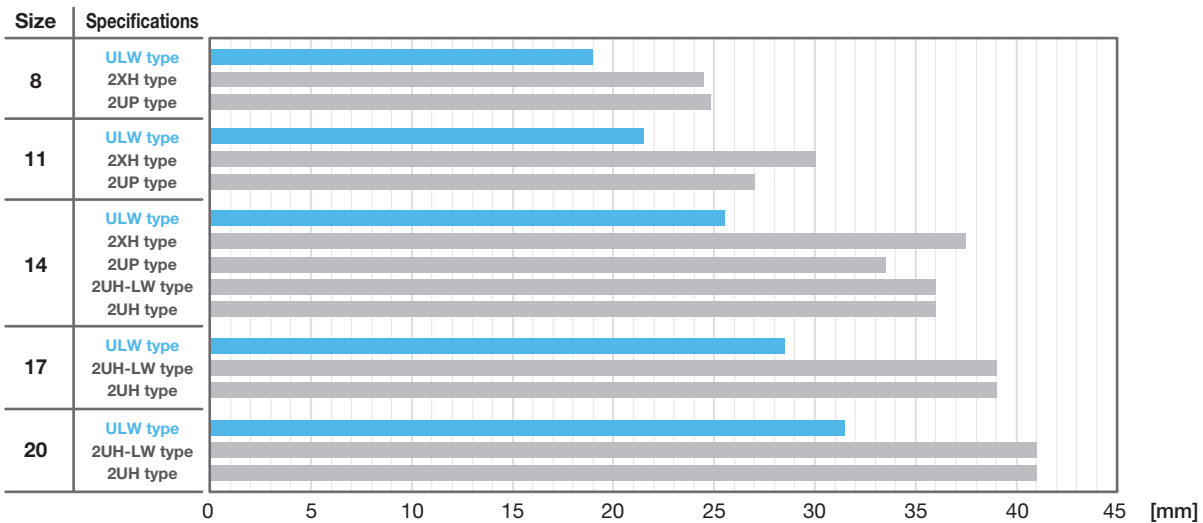

Comparison of allowable moment load

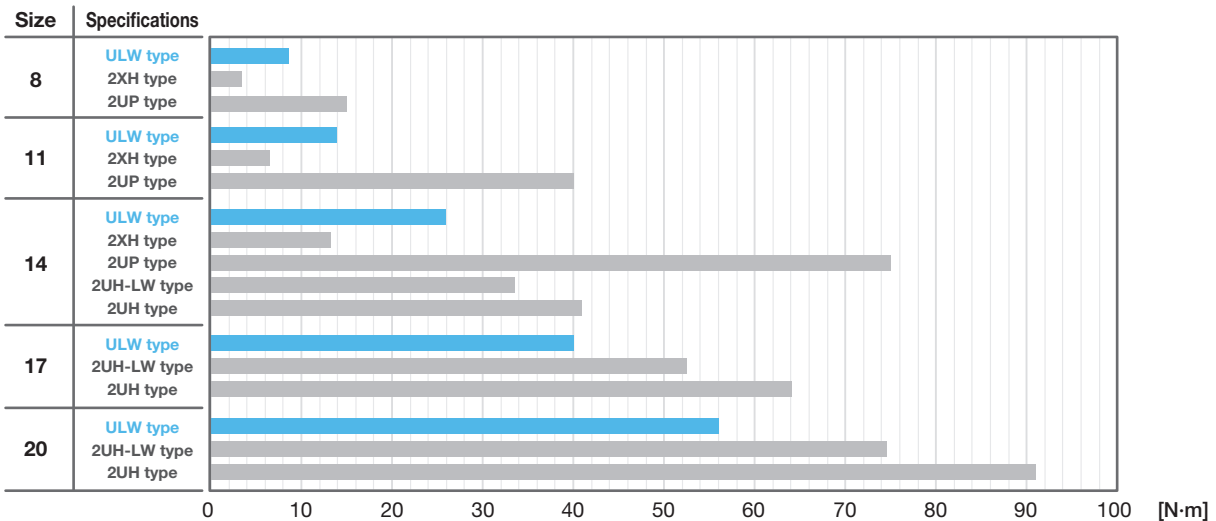

Ordering Code

CSF - 8 - 50 - 2UH - ULW - Specifications

Model	Size	Reduction ratio						Type	Specification 1	Special specifications
CSF series	8	30	50	-	100	-	-	2UH: Unit type	ULW: Ultra-light weight type	Blank = standard product SP = Special specifications such as the shape or performance
	11	30	50	-	100	-	-			
	14	-	50	80	100	-	-			
	17	-	50	80	100	120	-			
	20	-	50	80	100	120	160			

Rating Table

Size	Reduction ratio	Rated torque at input speed 2000 r/min		Limit for repeated peak torque		Limit for average torque		Limit for Momentary Peak Torque		Allowable maximum input speed r/min	Allowable average input speed r/min	Moment of Inertia (1/4GD ²) kg-m ²
		N-m	kgf-m	N-m	kgf-m	N-m	kgf-m	N-m	kgf-m			
8	30	0.9	0.09	1.8	0.18	1.4	0.14	3.3	0.34	8500	3500	1.7×10 ⁻⁷
	50	1.8	0.18	3.3	0.34	2.3	0.24	6.6	0.67			
	100	2.4	0.25	4.8	0.49	3.3	0.34	9.0	0.92			
11	30	2.2	0.22	4.5	0.46	3.4	0.35	8.5	0.87	8500	3500	8.6×10 ⁻⁷
	50	3.5	0.36	8.3	0.85	5.5	0.56	17	1.7			
	100	5.0	0.51	11	1.1	8.9	0.91	25	2.6			
14	50	5.4	0.55	18	1.8	6.9	0.7	35	3.6	8500	3500	2.2×10 ⁻⁶
	80	7.8	0.80	23	2.4	11	1.1	47	4.8			
	100	7.8	0.80	28	2.9	11	1.1	54	5.5			
17	50	16	1.6	34	3.5	26	2.6	70	7.1	7300	3500	5.5×10 ⁻⁶
	80	22	2.2	43	4.4	27	2.7	87	8.9			
	100	24	2.4	54	5.5	39	4.0	108	11			
	120	24	2.4	54	5.5	39	4.0	86	8.8			
20	50	25	2.5	56	5.7	34	3.5	98	10	6500	3500	1.1×10 ⁻⁵
	80	34	3.5	74	7.5	47	4.8	127	13			
	100	40	4.1	82	8.4	49	5.0	147	15			
	120	40	4.1	87	8.9	49	5.0	147	15			
	160	40	4.1	92	9.4	49	5.0	147	15			

Outline Drawing

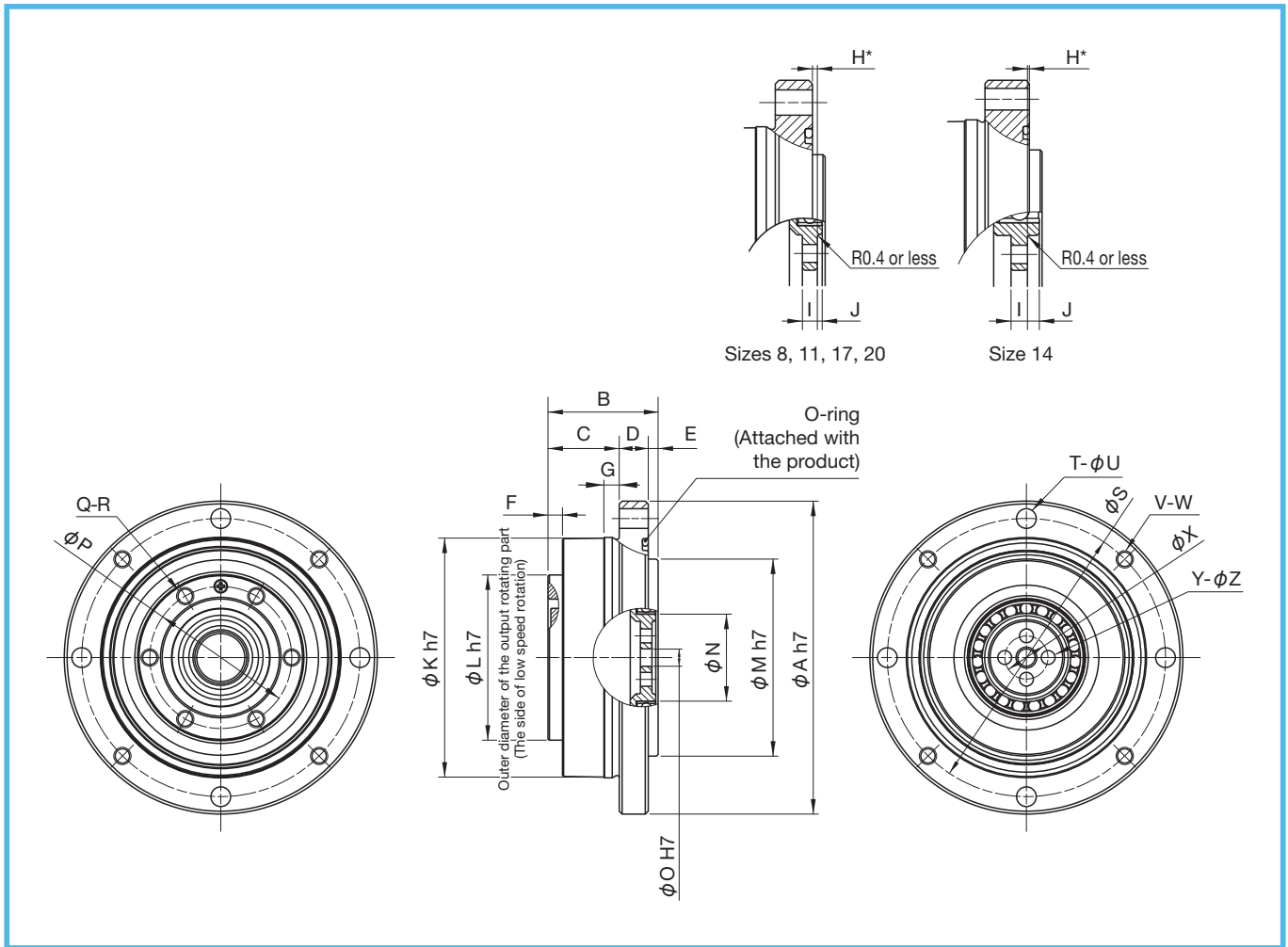

Dimension Table

[Unit: mm]

Size	Symbol	φA h7	B	C	D	E	F	G	H*	I	J	φK h7	φL h7	φM h7	φN
8		54	19.0	12.3	5.0	1.7	2.5	2.5	0.65 ⁰ _{-0.3}	2.0	0.7	41.5	28.5	34	12.5
11		63	21.5	13.0	6.5	2.0	2.5	3.3	0.35 ⁰ _{-0.7}	2.4	1.3	50.5	36.5	42	18.2
14		71	25.5	16.5	7.0	2.0	2.5	3.0	0.30 ^{+0.8} ₀	2.6	1.88	58.5	43.5	49	22.0
17		81	28.5	18.0	8.0	2.5	2.5	3.0	0.20 ⁰ _{-0.9}	2.7	2.0	67.5	52.0	57	26.5
20		93	31.5	20.5	8.0	3.0	2.5	3.0	0.30 ⁰ _{-1.0}	3.1	2.6	77.0	60.5	63	31.5

Size	Symbol	φO H7	φP	Q	R	φS	T	U	V	W	X	Y	Z	Weight (g)
8		3	24.5	6	M3×4.0	48.0	4	3.4	4	M3	7.5	4	2.4	90
11		7	32.0	8	M3×4.5	57.0	4	3.4	4	M3	12.0	4	2.9	150
14		11	39.0	10	M3×4.5	65.0	6	3.4	6	M3	16.0	4	2.9	230
17		13	47.5	16	M3×4.5	74.5	10	3.4	10	M3	19.5	4	3.4	320
20		19	56.0	18	M3×4.5	84.5	12	3.4	12	M3	25.5	4	3.4	450

* The H dimension is the axial fitting position and tolerance of the three parts (Wave Generator, Flexpline and Circular Spline) that make up the HarmonicDrive®. Please be sure to observe this dimension as it will affect its performance and strength.

Rotational Transmission Error

Reduction ratio		Size	8	11	14	17	20
30	x10 ⁻⁴ rad		5.8	5.8	–	–	–
	arc-min		2.0	2.0	–	–	–
50 or higher	x10 ⁻⁴ rad		5.8	4.4	4.4	4.4	2.9
	arc-min		2.0	1.5	1.5	1.5	1.0

Hysteresis Loss

Reduction ratio		Size	8	11	14	17	20
30	x10 ⁻⁴ rad		8.7	8.7	–	–	–
	arc-min		3.0	3.0	–	–	–
50	x10 ⁻⁴ rad		5.8	5.8	5.8	5.8	5.8
	arc-min		2.0	2.0	2.0	2.0	2.0
80 or higher	x10 ⁻⁴ rad		5.8	5.8	2.9	2.9	2.9
	arc-min		2.0	2.0	1.0	1.0	1.0

Stiffness (spring constant)

Symbol		Size	8	11	14	17	20
T1	N·m		0.29	0.8	2.0	3.9	7.0
	kgf·m		0.03	0.082	0.2	0.4	0.7
T2	N·m		0.75	2.0	6.9	12.0	25.0
	kgf·m		0.077	0.2	0.7	1.2	2.5
Reduction ratio 30	K1	x10 ⁴ N·m/rad	0.034	0.084	–	–	–
		kgf·m/arc-min	0.010	0.025	–	–	–
	K2	x10 ⁴ N·m/rad	0.044	0.130	–	–	–
		kgf·m/arc-min	0.013	0.037	–	–	–
	K3	x10 ⁴ N·m/rad	0.054	0.160	–	–	–
		kgf·m/arc-min	0.016	0.047	–	–	–
θ1	x10 ⁻⁴ rad		8.5	9.5	–	–	–
	arc-min		3.0	3.3	–	–	–
θ2	x10 ⁻⁴ rad		19	19	–	–	–
	arc-min		6.6	6.5	–	–	–
Reduction ratio 50	K1	x10 ⁴ N·m/rad	0.044	0.22	0.34	0.81	1.3
		kgf·m/arc-min	0.013	0.066	0.1	0.24	0.38
	K2	x10 ⁴ N·m/rad	0.067	0.30	0.47	1.1	1.8
		kgf·m/arc-min	0.02	0.09	0.14	0.32	0.52
	K3	x10 ⁴ N·m/rad	0.084	0.32	0.57	1.3	2.3
		kgf·m/arc-min	0.025	0.096	0.17	0.4	0.67
θ1	x10 ⁻⁴ rad		6.6	3.6	5.8	4.9	5.2
	arc-min		2.3	1.2	2.0	1.7	1.8
θ2	x10 ⁻⁴ rad		13	8	16	12	15.4
	arc-min		4.7	2.6	5.6	4.2	5.3
Reduction ratio 80 or higher	K1	x10 ⁴ N·m/rad	0.091	0.27	0.47	1	1.6
		kgf·m/arc-min	0.027	0.08	0.14	0.3	0.47
	K2	x10 ⁴ N·m/rad	0.1	0.34	0.61	1.4	2.5
		kgf·m/arc-min	0.031	0.10	0.18	0.4	0.75
	K3	x10 ⁴ N·m/rad	0.12	0.44	0.71	1.6	2.9
		kgf·m/arc-min	0.036	0.13	0.21	0.46	0.85
θ1	x10 ⁻⁴ rad		3.2	3.0	4.1	3.9	4.4
	arc-min		1.1	1.0	1.4	1.3	1.5
θ2	x10 ⁻⁴ rad		8.0	6.0	12	9.7	11.3
	arc-min		2.6	2.2	4.2	3.3	3.9

* This table shows the reference values. The lower limit value is approximately 80% of the displayed value.

Starting Torque

(Unit: cN·m)

Reduction ratio \ Size	8	11	14	17	20
30	1.5	3	–	–	–
50	0.9	1.8	3.6	5.5	7.2
80	–	–	2.6	3.6	4.5
100	0.7	1.2	2.3	3.1	4.0
120	–	–	–	2.9	3.6
160	–	–	–	–	3.1

Backdriving torque

(Unit: N·m)

Reduction ratio \ Size	8	11	14	17	20
30	0.7	1.4	–	–	–
50	0.55	1.1	1.6	2.7	4.3
80	–	–	1.6	2.7	4.5
100	0.75	1.5	1.9	3.0	4.8
120	–	–	–	3.3	5.2
160	–	–	–	–	6.1

Positive Input Breaking Torque

If excessive torque is applied that exceeds the range of use, ratcheting, damage to the fastening part etc. and other damage that makes continuous use impossible will occur with a single load.

The minimum torque that causes such damage is defined as the positive input breaking torque.

(Unit: N·m)

Reduction ratio \ Size	8	11	14	17	20
30	15	40	–	–	–
50	16	47	88	150	220
80	–	–	110	200	350
100	19	60	84	160	260
120	–	–	–	120	240
160	–	–	–	–	220

Buckling torque

(Unit: N·m)

Reduction ratio \ Size	8	11	14	17	20
Total reduction ratio	35	90	190	330	510

No-load Running Torque

No-load running torque is the input torque (high-speed shaft side) required to rotate a HarmonicDrive® under a no-load condition.

* For detailed value, please contact our sales department.

Measuring condition

Lubrication condition	Speed reducer (Size 8, 11, 14, 17)	Speed reducer (Size 20)	Main bearing
	Harmonic Grease® SK-2	Harmonic Grease® SK -1A	Multemp HL-D*

The torque value is measured after two or more hours run-in at 2000 r/min input speed.

* "Multemp" is a registered trademark of Kyodo Yushi Co., Ltd.

Compensation Amount of No-load Running Torque

(Unit: cN·m)

Reduction ratio \ Size	8	11	14	17	20
30	0.54	1.05	-	-	-
50	0.23	0.43	0.63	1.01	1.54
80	-	-	0.11	0.17	0.27
120	-	-	-	-0.13	-0.19
160	-	-	-	-	-0.45

* The efficiency compensation amount of size 8, 11 is the average value when the grease temperature is approximately 30°C.

No-load Running Torque of Reduction Ratio 100

Input rotational speed 500r/min

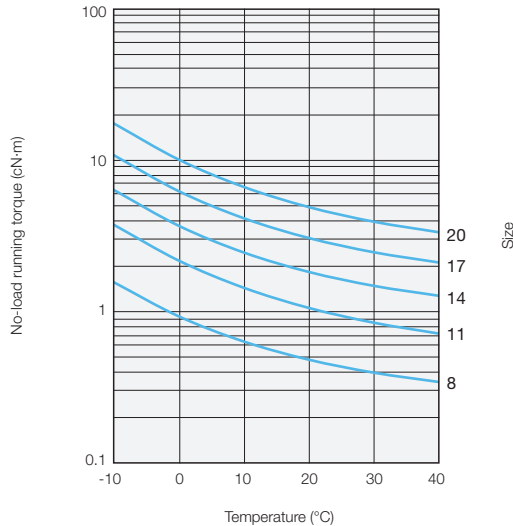

Input rotational speed 1000r/min

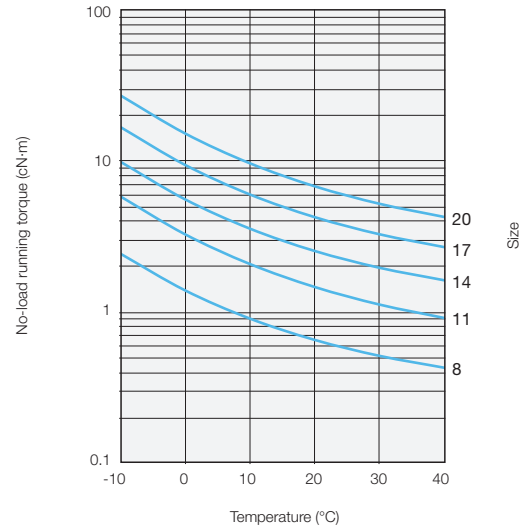

Input rotational speed 2000r/min

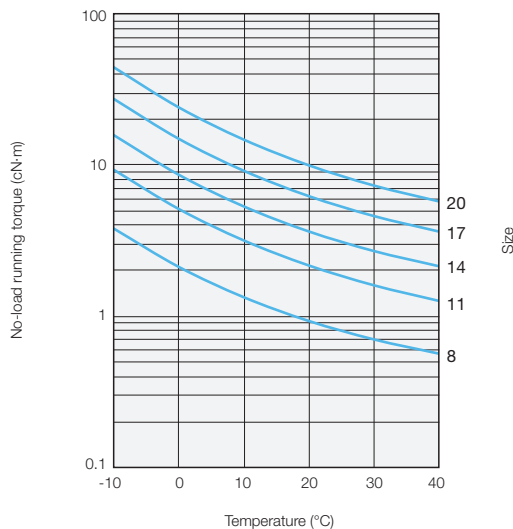

Input rotational speed 3500r/min

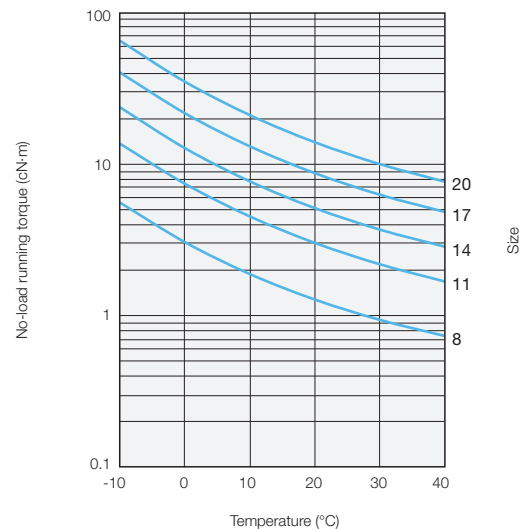

* The graphs show the average value X.

Efficiency Characteristics

The efficiency is varied depending on the load torque. Obtain efficiency compensation coefficient K_e from the graph, and check the value through the following formula.

*1 The efficiency compensation coefficient is the average value when the grease temperature is approximately 30°C.

*2 When load torque is larger than rated torque, efficiency compensation coefficient is $K_e = 1$.

Efficiency compensation coefficient: K_e

Efficiency at rated torque: η_R

Efficiency depending on the load torque: η

$$\eta = K_e \times \eta_R$$

Measuring condition

Lubrication condition	Speed reducer 8, 11, 14, 17	Speed reducer (Size 20)	Main bearing
	Harmonic Grease® SK-2	Harmonic Grease® SK -1A	Multemp HL-D*

The torque value is measured after two or more hours run-in at 2000 r/min input speed.

* "Multemp" is a registered trademark of Kyodo Yushi Co., Ltd.

Efficiency compensation coefficient

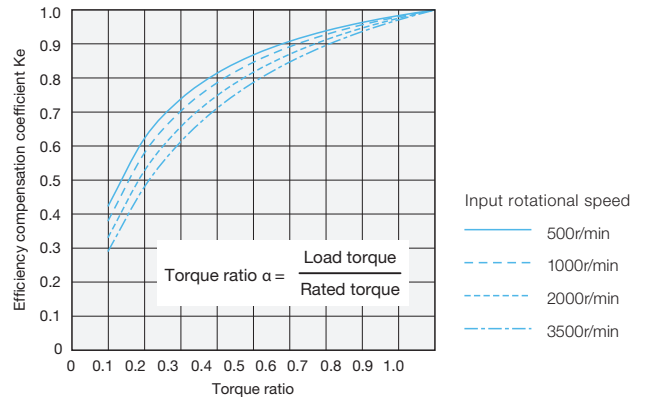

Efficiency at rated torque

Size 8

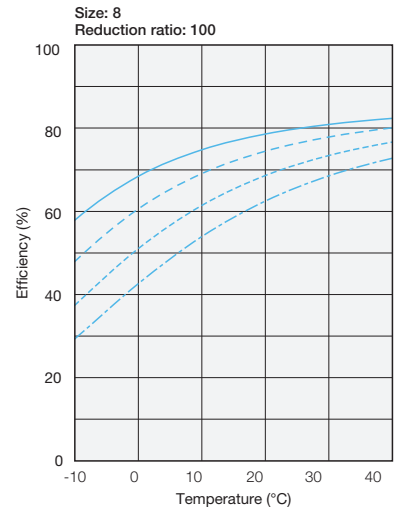
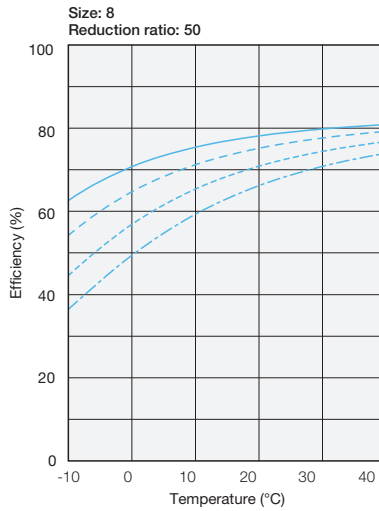
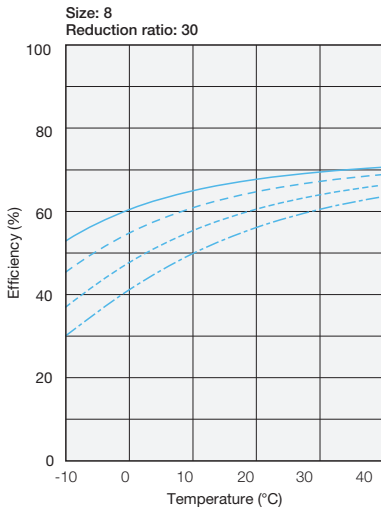

Size 11

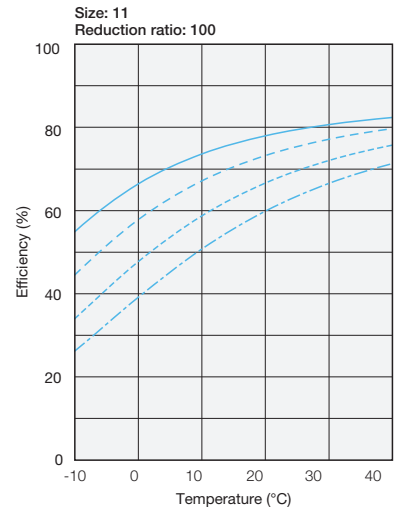
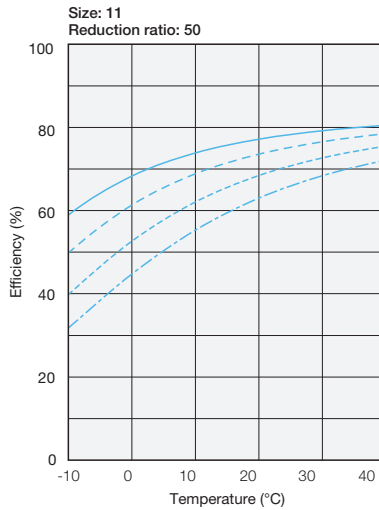
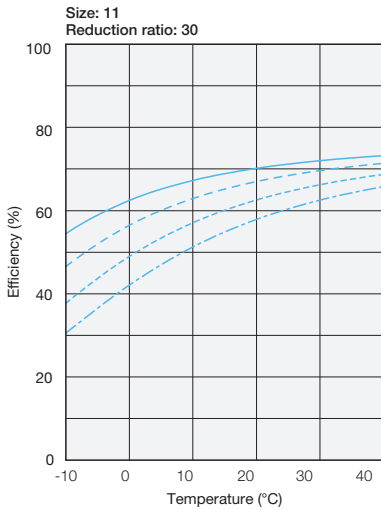

* The graphs show the average value X.

Size 14

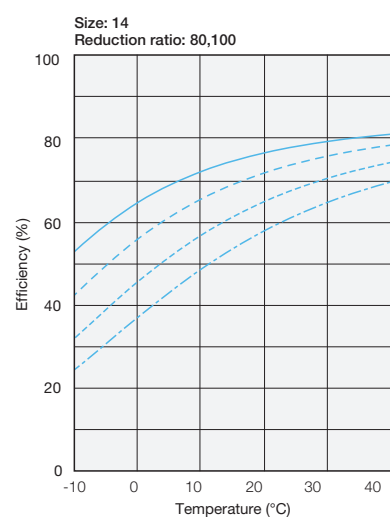
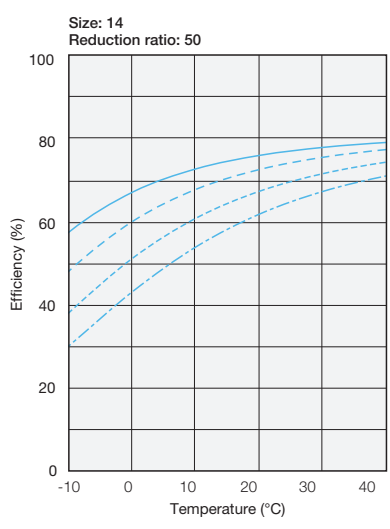

Size 17

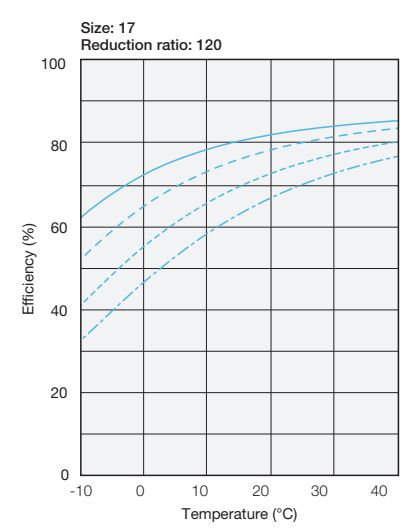
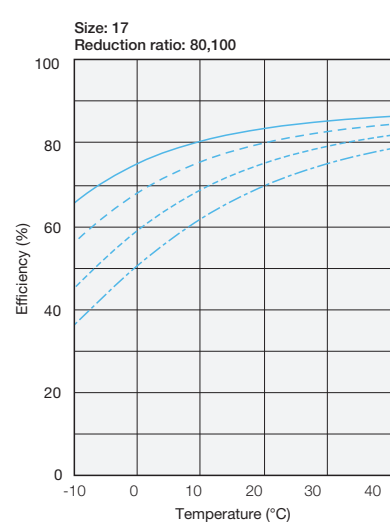
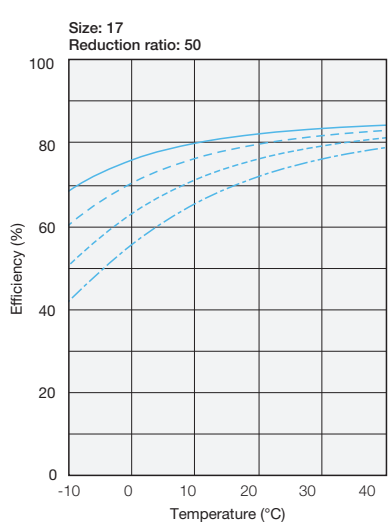

* The graphs show the average value X.

Size 20

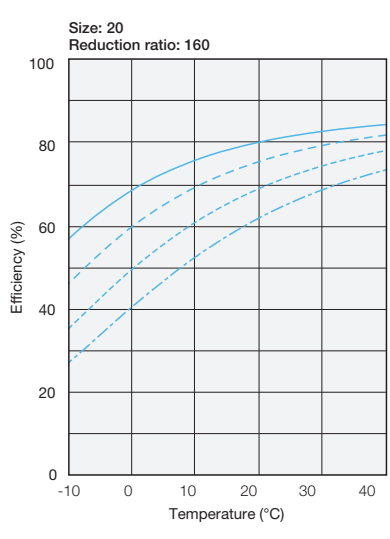
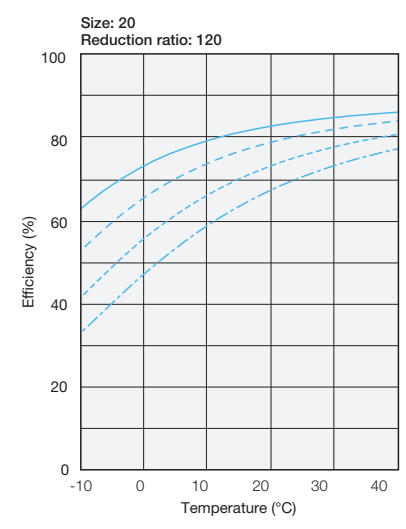
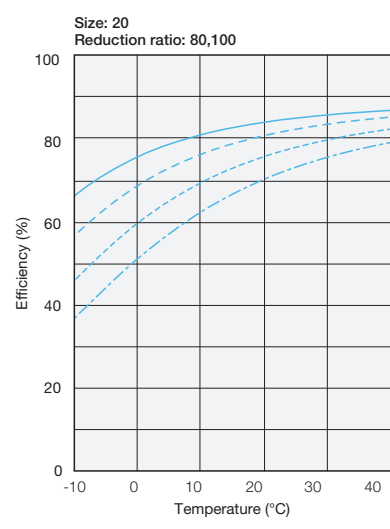
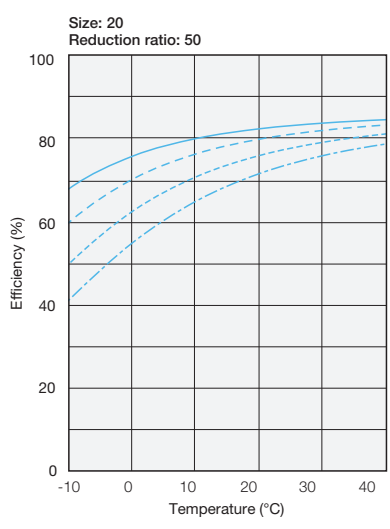

* The graphs show the average value X.

Specifications of the Main Bearing

The CSF-ULW series incorporates a small 4-point contact ball bearing to directly support the external load (output part). Please check the maximum moment load, the life of the small 4-point contact ball bearing and the static safety coefficient to fully exert the performance of the CSF-ULW series.

Checking procedure

For details of the checking procedure, refer to the “Checking Main Roller Bearing” in the “Engineering Data” in the HarmonicDrive® General Catalog.

(1) Checking the maximum moment load (M max)



(2) Checking the life

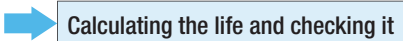

(3) Checking the static safety coefficient

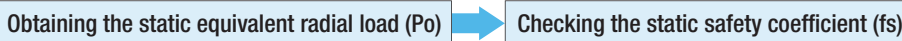

Main bearing specifications

Size	Pitch circle	Offset	Basic rated load		Allowable moment load Mc	Moment stiffness Km
	dp	R	Basic dynamic load rating C	Basic static load rating C0		
	mm	mm	N	N		
8	29	7.9	1.8×10 ³	2.2×10 ³	8.7	1.0×10 ⁴
11	37.1	8.15	2.8×10 ³	3.5×10 ³	14	1.7×10 ⁴
14	44.3	8.4	3.9×10 ³	5.0×10 ³	26	3.0×10 ⁴
17	52.7	9.2	5.2×10 ³	7.0×10 ³	40	4.6×10 ⁴
20	61.4	9.7	6.7×10 ³	9.4×10 ³	56	6.5×10 ⁴

- * The basic dynamic load rating is a constant static radial load that provides a basic dynamic rating life of bearings to reach 1 million rotations.
- * The basic static load rating is the static load that gives a certain level of contact stress (4.2kN/mm²) at the center of the contact area between the rolling element and raceway, which receives the maximum load.
- * The allowable moment load is the maximum moment load that can be applied to the output shaft. Within this range, the basic performance is maintained, and the operation is possible for this value.
- * The value of moment rigidity is a reference value, and the lower limit is approximately 80% of the displayed value. The lower limit value is approximately 80% of the displayed value.

Mechanical Accuracy

CSF-2UH-ULW series have four-point contact ball bearing of high accuracy on main shaft bearing, and realized the high mechanical accuracy of output part.

The mechanical accuracy of the output shaft is shown below.

Symbol	Accuracy Item	Size				
		8	11	14	17	20
a	Output shaft radial runout	0.010	0.010	0.010	0.010	0.010
b	Mounting pilot concentricity	0.050	0.050	0.060	0.060	0.070
c	Output flange axial runout	0.010	0.010	0.010	0.010	0.010
d	Parallelism between the mounting face and the output flange face	0.025	0.025	0.025	0.025	0.025

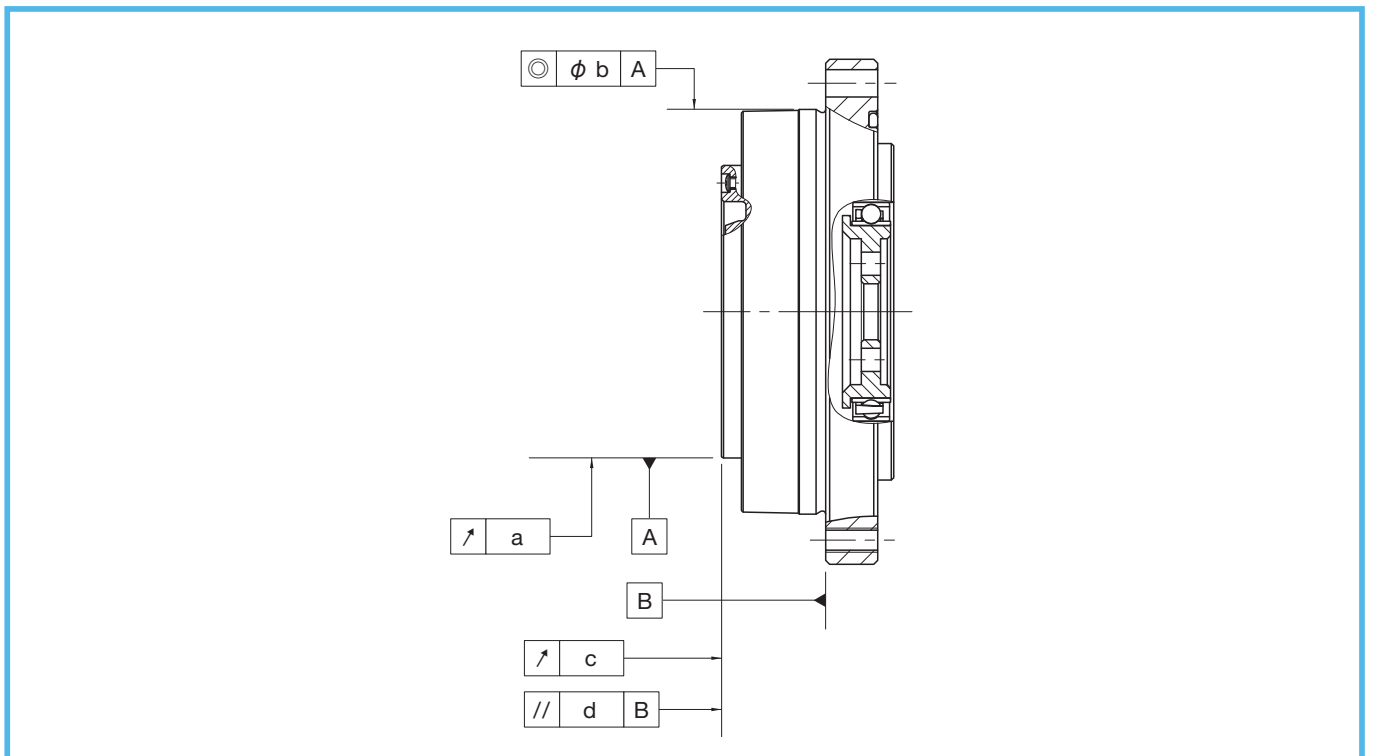

Lubrication

Grease lubrication is the standard lubrication of the CSF-2UH-ULW series.

The product is shipped while the grease is sealed, and adding or application of the grease is not required when installing the product.

The following grease is used as the lubrication agent.

Lubrication part	Speed reducer (Size 8, 11, 14, 17)	Speed reducer (Size 20)	Main bearing
Lubrication agent to be used	Harmonic Grease® SK-2	Harmonic Grease® SK -1A	Multemp HL-D
Manufacturers	Harmonic Drive Systems Inc.	Harmonic Drive Systems Inc.	Kyodo Yushi Co., Ltd.
Base oil	Purified mineral oil	Purified mineral oil	Synthetic hydrocarbon oil
Thickener	Lithium soap base	Lithium soap base	Lithium soap base
Mixing consistency (25°C)	295	295	280
Drop point	198°C	197°C	210°C
Appearance	Green viscous state	Yellow viscous state	White viscous state

Installation Accuracy

When installation, be sure to retain the recommended accuracy in below in order to fully realize the excellent performance of the CSF-2UH-ULW series.

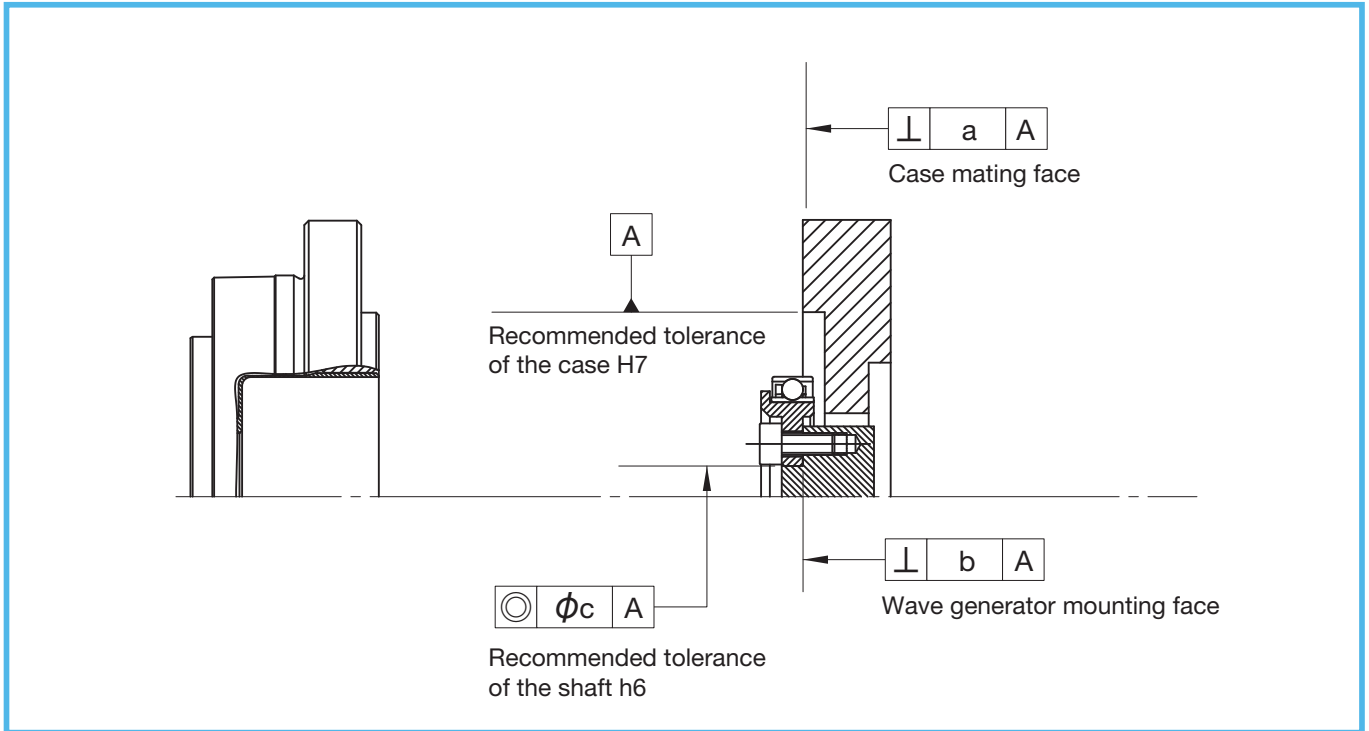

Symbol	Accuracy Item	Size				
		8	11	14	17	20
a	Squareness of the case mating face	0.010	0.011	0.011	0.015	0.017
b	Squareness of the wave generator mounting face	0.006	0.007	0.008	0.010	0.010
c	Concentricity of the input shaft	0.006	0.007	0.016	0.018	0.019

Installation and Transmission Torque

Precautions when installing the product

Regarding the installation design, if the product is installed abnormally or forcibly and the installation face is damaged, the performance may be reduced. Prevent the failures described below to fully exert the performance of the unit type.

- Distortion or deformation of the installation face
- Inclusion of foreign matter
- Burrs or elevation of the area around the tap of the installation hole and error in the position accuracy
- Insufficiently chamfer of the installation pilot part
- Abnormal roundness of the installation pilot part

Installation on the device

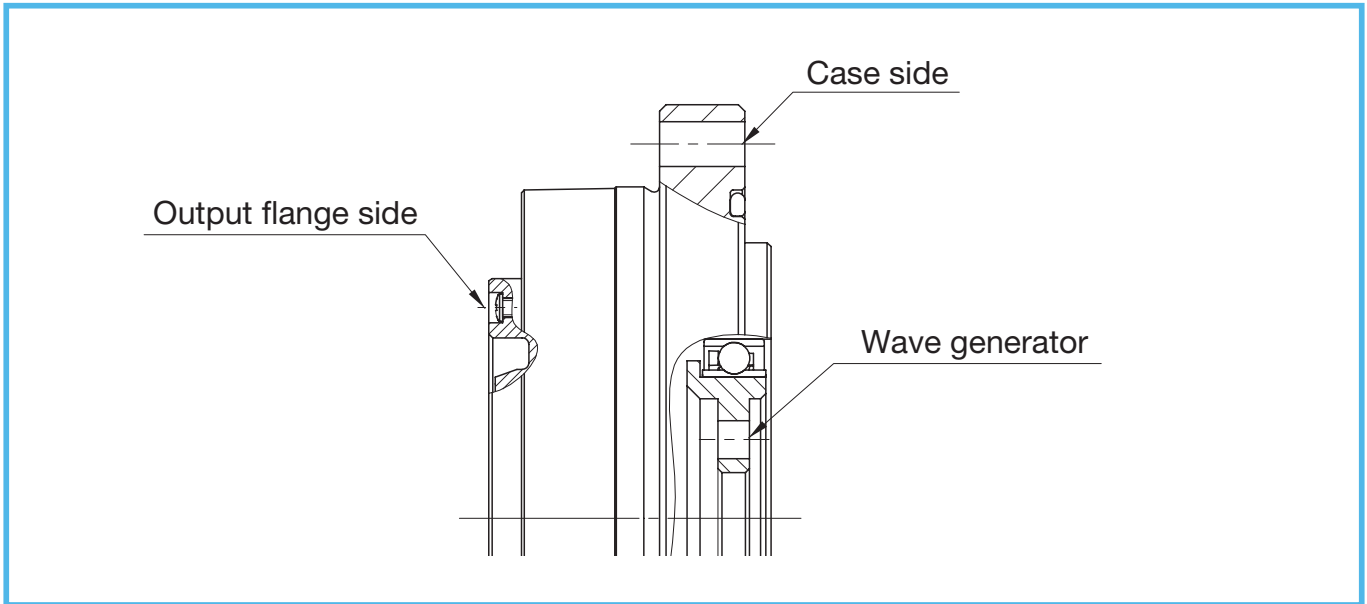

Installation and transmission torque on the output flange side

Item		Size	8	11	14	17	20
Number of bolts			6	8	10	16	18
Bolt size			M3	M3	M3	M3	M3
Mounting P.C.D	mm		24.5	32.0	39.0	47.5	56.0
	N·m		2.0	2.0	2.0	2.0	2.0
Bolt tightening torque	kgf·m		0.20	0.20	0.20	0.20	0.20
	N·m		30.6	53.3	81.2	158	210
Bolt transmission torque	kgf·m		3.12	5.43	8.28	16.1	21.4

Installation and transmission torque on case side

Item		Size	8	11	14	17	20
Number of bolts			4	4	6	10	12
Bolt size			M3	M3	M3	M3	M3
Mounting P.C.D	mm		48.0	57.0	65.0	74.5	84.5
	N·m		1.4	1.4	1.4	1.4	1.4
Bolt tightening torque	kgf·m		0.14	0.14	0.14	0.14	0.14
	N·m		28	33.2	56.8	108	147
Bolt transmission torque	kgf·m		2.85	3.38	5.79	11.0	14.9

Installation and transmission torque on wave generator

Item		Size	8	11	14	17	20
Number of bolts			4	4	4	4	4
Bolt size			M2	M2.5	M2.5	M3	M3
Mounting P.C.D	mm		7.5	12	16	19.5	25.5
Bolt tightening torque	N·m		0.54	1.08	1.08	2.0	2.0
	kgf·m		0.055	0.110	0.110	0.20	0.20
Bolt transmission torque	N·m		2.53	6.48	8.64	16.2	21.2
	kgf·m		0.25	0.66	0.88	1.6	2.1

Precautions for Use

Use only in a specified environment.

Ensure the following environmental conditions are complied with:

- Ambient temperature 0 to 40°C
- No splashing of water or oil
- Do not expose to corrosive or explosive gas
- No dust such as metal powder

* For other precautions, refer to the "HarmonicDrive® General Catalog."



■ Please contact our sales department with any questions.

Head Office

Ichigo Omori Building, 6-25-3 Minami-Oi,
Shinagawa-ku, Tokyo 140-0013 JAPAN
Phone: +81-3-5471-7800 / FAX: +81-3-5471-7811

Tokyo Office

Ichigo Omori Building, 6-25-3 Minami-Oi,
Shinagawa-ku, Tokyo 140-0013 JAPAN
Phone: +81-3-5471-7830 / FAX: +81-3-5471-7836

Tokyo Office, Kitakanto Team

Ichigo Omori Building, 6-25-3 Minami-Oi,
Shinagawa-ku, Tokyo 140-0013 JAPAN
Phone: +81-3-6410-8485 / FAX: +81-3-6410-8486

Koshin Office

5103-1 Hotakaariake, Azumino-shi, Nagano
399-8301 JAPAN
Phone: +81-263-81-5940 / FAX: +81-263-50-5010

Chubu Office

TM21-2F, 21 Terugaoka, Meito-ku, Nagoya-shi,
Aichi 465-0042 JAPAN
Phone: +81-52-773-7451 / FAX: +81-52-773-7462

Kansai Office

Shin-Osaka Ueno Toyo Building 3F, 7-4-17 Nishi-nakajima,
Yodogawa-ku, Osaka-shi, Osaka 532-0011 JAPAN
Phone: +81-6-6885-5720 / FAX: +81-6-6885-5725

Kyushu Office

NMF Hakata-ekimae Building 7F, 1-15-20 Hakata-ekimae,
Hakata-ku, Fukuokashi, Fukuoka 812-0011 JAPAN
Phone: +81-92-451-7208 / FAX: +81-92-481-2493

Overseas Division

5103-1 Hotakaariake, Azumino-shi, Nagano
399-8301 JAPAN
Phone: +81-263-81-5950 / FAX: +81-263-50-5010

Hataka Plant

1856-1 Hotakamaki, Azumino-shi, Nagano
399-8305 JAPAN
Phone: +81-263-83-6935 / FAX: +81-263-83-6901

"HarmonicDrive" is a trademark of Harmonic Drive Systems Inc.

The academic or generic term of our "HarmonicDrive" products is "strain wave gearing".